

6 5 4 3 2 1

D

D

C

C

B

B

A

A

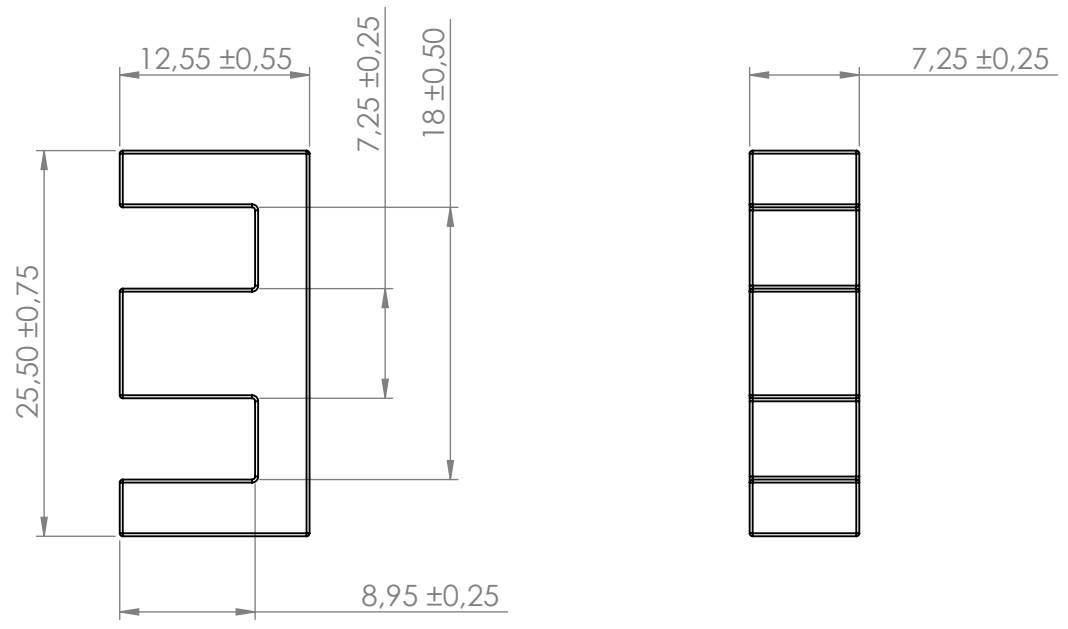
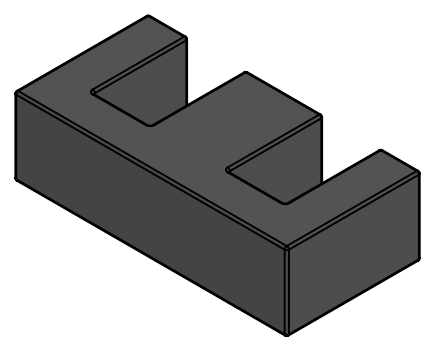

	FERYSTER sp.j. B. i Z. Sobków ul. Traugutta 4, 68-120 ŁĘOWA info@feryster.pl
NR RYSUNKU FERCORE E25-13-7 (EF-25)	A4
SKALA: 2:1	ARKUSZ 1 Z 1

Pełna dokumentacja techniczna oraz materiały pomocnicze dla projektantów www.feryster.pl

6 5 4 3 2 1