

# DATA SHEET

**E14/3.5/5**

Planar E cores and accessories

Supersedes data of February 2002

2004 Sep 01

**CORES**

**Effective core parameters of a set of E cores**

SYMBOL	PARAMETER	VALUE	UNIT
$\Sigma(l/A)$	core factor (C1)	1.43	mm <sup>-1</sup>
$V_e$	effective volume	300	mm <sup>3</sup>
$l_e$	effective length	20.7	mm
$A_e$	effective area	14.3	mm <sup>2</sup>
$A_{min}$	minimum area	14.3	mm <sup>2</sup>
$m$	mass of core half	≈ 0.6	g

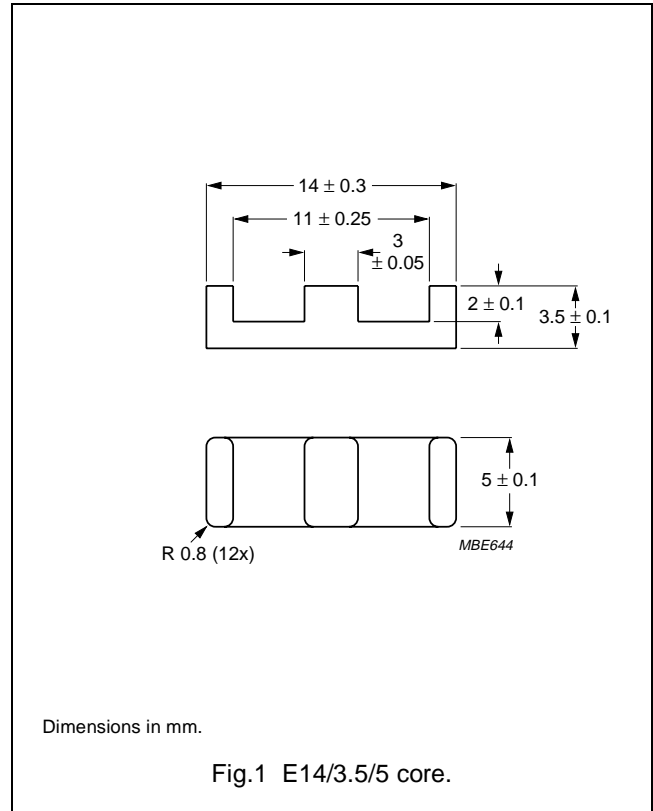

**Effective core parameters of an E/PLT combination**

SYMBOL	PARAMETER	VALUE	UNIT
$\Sigma(l/A)$	core factor (C1)	1.16	mm <sup>-1</sup>
$V_e$	effective volume	240	mm <sup>3</sup>
$l_e$	effective length	16.7	mm
$A_e$	effective area	14.5	mm <sup>2</sup>
$A_{min}$	minimum area	14.5	mm <sup>2</sup>
$m$	mass of plate	≈ 0.5	g

**Ordering information for plates**

GRADE	TYPE NUMBER
3C90	PLT14/5/1.5-3C90
3C92 <small>des</small>	PLT14/5/1.5-3C92
3C93 <small>des</small>	PLT14/5/1.5-3C93
3C94	PLT14/5/1.5-3C94
3C96 <small>des</small>	PLT14/5/1.5-3C96
3F3	PLT14/5/1.5-3F3
3F35 <small>prot</small>	PLT14/5/1.5-3F35
3F4 <small>des</small>	PLT14/5/1.5-3F4
3F45 <small>prot</small>	PLT14/5/1.5-3F45
3E6	PLT14/5/1.5-3E6

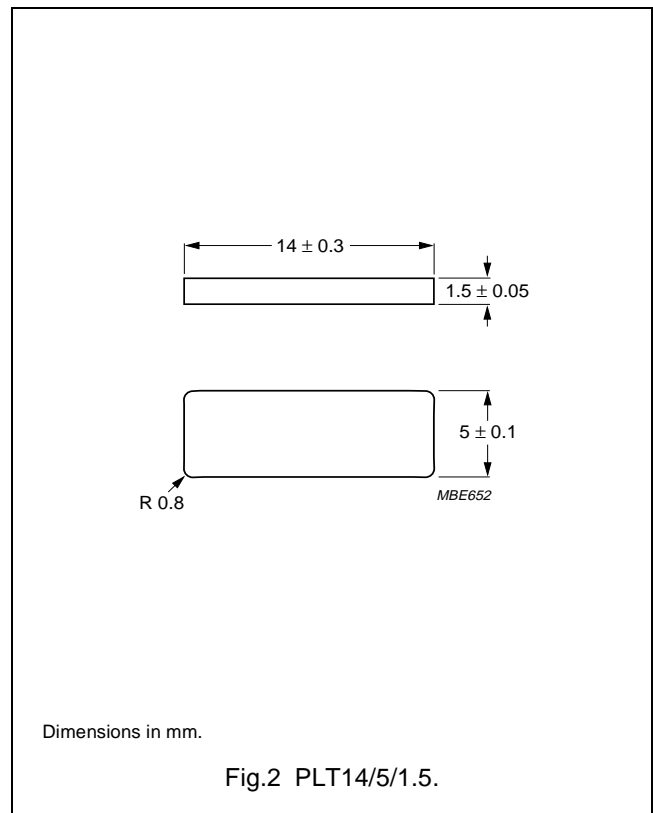

## Planar E cores and accessories

E14/3.5/5

**Core halves for use in combination with an ungapped E core**

$A_L$  measured in combination with a non-gapped core half, clamping force for  $A_L$  measurements,  $10 \pm 5$  N, using a PCB coil containing 4 layers of 8 tracks each, total height 1.6 mm.

GRADE	$A_L$ (nH)	$\mu_e$	AIR GAP ( $\mu\text{m}$ )	TYPE NUMBER
3C90	$63 \pm 3\%$	$\approx 72$	$\approx 530$	E14/3.5/5-3C90-A63-E
	$100 \pm 5\%$	$\approx 114$	$\approx 270$	E14/3.5/5-3C90-A100-E
	$160 \pm 8\%$	$\approx 182$	$\approx 130$	E14/3.5/5-3C90-A160-E
	$1280 \pm 25\%$	$\approx 1450$	$\approx 0$	E14/3.5/5-3C90
3C92 <b>des</b>	$960 \pm 25\%$	$\approx 1090$	$\approx 0$	E14/3.5/5-3C92
3C93 <b>des</b>	$1100 \pm 25\%$	$\approx 1250$	$\approx 0$	E14/3.5/5-3C93
3C94	$63 \pm 3\%$	$\approx 72$	$\approx 530$	E14/3.5/5-3C94-A63-E
	$100 \pm 5\%$	$\approx 114$	$\approx 270$	E14/3.5/5-3C94-A100-E
	$160 \pm 8\%$	$\approx 182$	$\approx 130$	E14/3.5/5-3C94-A160-E
	$1280 \pm 25\%$	$\approx 1450$	$\approx 0$	E14/3.5/5-3C94
3C96 <b>des</b>	$1200 \pm 25\%$	$\approx 1360$	$\approx 0$	E14/3.5/5-3C96
3F3	$63 \pm 3\%$	$\approx 72$	$\approx 530$	E14/3.5/5-3F3-A63-E
	$100 \pm 5\%$	$\approx 114$	$\approx 270$	E14/3.5/5-3F3-A100-E
	$160 \pm 8\%$	$\approx 182$	$\approx 130$	E14/3.5/5-3F3-A160-E
	$1100 \pm 25\%$	$\approx 1250$	$\approx 0$	E14/3.5/5-3F3
3F35 <b>prot</b>	$900 \pm 25\%$	$\approx 1020$	$\approx 0$	E14/3.5/5-3F35
3F4 <b>des</b>	$63 \pm 3\%$	$\approx 72$	$\approx 530$	E14/3.5/5-3F4-A63-E
	$100 \pm 5\%$	$\approx 114$	$\approx 270$	E14/3.5/5-3F4-A100-E
	$160 \pm 8\%$	$\approx 182$	$\approx 130$	E14/3.5/5-3F4-A160-E
	$650 \pm 25\%$	$\approx 740$	$\approx 0$	E14/3.5/5-3F4
3F45 <b>prot</b>	$650 \pm 25\%$	$\approx 740$	$\approx 0$	E14/3.5/5-3F45
3E6	$5600 +40/-30\%$	$\approx 6360$	$\approx 0$	E14/3.5/5-3E6

## Planar E cores and accessories

E14/3.5/5

**Core halves for use in combination with a plate (PLT)**

$A_L$  measured in combination with a plate (PLT) clamping force for  $A_L$  measurements,  $10 \pm 5$  N, using a PCB coil containing 4 layers of 8 tracks each, total height 1.6 mm.

GRADE	$A_L$ (nH)	$\mu_e$	AIR GAP ( $\mu\text{m}$ )	TYPE NUMBER
3C90	63 $\pm 3\%$	$\approx 58$	$\approx 600$	E14/3.5/5-3C90-A63-P
	100 $\pm 5\%$	$\approx 92$	$\approx 300$	E14/3.5/5-3C90-A100-P
	160 $\pm 8\%$	$\approx 148$	$\approx 150$	E14/3.5/5-3C90-A160-P
	1500 $\pm 25\%$	$\approx 1400$	$\approx 0$	E14/3.5/5-3C90
3C92 <b>des</b>	1130 $\pm 25\%$	$\approx 1040$	$\approx 0$	E14/3.5/5-3C92
3C93 <b>des</b>	1300 $\pm 25\%$	$\approx 1200$	$\approx 0$	E14/3.5/5-3C93
3C94	63 $\pm 3\%$	$\approx 58$	$\approx 600$	E14/3.5/5-3C94-A63-P
	100 $\pm 5\%$	$\approx 92$	$\approx 300$	E14/3.5/5-3C94-A100-P
	160 $\pm 8\%$	$\approx 148$	$\approx 150$	E14/3.5/5-3C94-A160-P
	1500 $\pm 25\%$	$\approx 1400$	$\approx 0$	E14/3.5/5-3C94
3C96 <b>des</b>	1350 $\pm 25\%$	$\approx 1260$	$\approx 0$	E14/3.5/5-3C96
3F3	63 $\pm 3\%$	$\approx 58$	$\approx 600$	E14/3.5/5-3F3-A63-P
	100 $\pm 5\%$	$\approx 92$	$\approx 300$	E14/3.5/5-3F3-A100-P
	160 $\pm 8\%$	$\approx 148$	$\approx 150$	E14/3.5/5-3F3-A160-P
	1300 $\pm 25\%$	$\approx 1200$	$\approx 0$	E14/3.5/5-3F3
3F35 <b>prot</b>	1050 $\pm 25\%$	$\approx 980$	$\approx 0$	E14/3.5/5-3F35
3F4 <b>des</b>	63 $\pm 3\%$	$\approx 58$	$\approx 600$	E14/3.5/5-3F4-A63-P
	100 $\pm 5\%$	$\approx 92$	$\approx 300$	E14/3.5/5-3F4-A100-P
	160 $\pm 8\%$	$\approx 148$	$\approx 150$	E14/3.5/5-3F4-A160-P
	780 $\pm 25\%$	$\approx 720$	$\approx 0$	E14/3.5/5-3F4
3F45 <b>prot</b>	780 $\pm 25\%$	$\approx 720$	$\approx 0$	E14/3.5/5-3F45
3E6	6400 +40/-30%	$\approx 5900$	$\approx 0$	E14/3.5/5-3E6

## Planar E cores and accessories

E14/3.5/5

## Properties of core sets under power conditions

GRADE	B (mT) at	CORE LOSS (W) at			
	H = 250 A/m; f = 10 kHz; T = 100 °C	f = 100 kHz; $\hat{B}$ = 100 mT; T = 100 °C	f = 100 kHz; $\hat{B}$ = 200 mT; T = 100 °C	f = 400 kHz; $\hat{B}$ = 50 mT; T = 100 °C	f = 500 kHz; $\hat{B}$ = 50 mT; T = 100 °C
E+E14-3C90	≥320	≤ 0.030	–	–	–
E+PLT14-3C90	≥320	≤ 0.026	–	–	–
E+E14-3C92	≥370	≤ 0.024	≤ 0.16	–	–
E+PLT14-3C92	≥370	≤ 0.021	≤ 0.15	–	–
E+E14-3C93	≥320	≤ 0.024 <sup>(1)</sup>	≤ 0.16 <sup>(1)</sup>	–	–
E+PLT14-3C93	≥320	≤ 0.021 <sup>(1)</sup>	≤ 0.15 <sup>(1)</sup>	–	–
E+E14-3C94	≥320	≤ 0.024	≤ 0.16	–	–
E+PLT14-3C94	≥320	≤ 0.021	≤ 0.15	–	–
E+E14-3C96	≥340	≤ 0.019	≤ 0.13	≤ 0.05	≤ 0.11
E+PLT14-3C96	≥340	≤ 0.016	≤ 0.12	≤ 0.045	≤ 0.09
E+E14-3F3	≥300	≤ 0.033	–	≤ 0.06	–
E+PLT14-3F3	≥300	≤ 0.027	–	≤ 0.047	–
E+E14-3F35	≥300	–	–	≤ 0.03	≤ 0.05
E+PLT14-3F35	≥300	–	–	≤ 0.024	≤ 0.035

1. Measured at 140 °C.

## Properties of core sets under power conditions (continued)

GRADE	B (mT) at	CORE LOSS (W) at			
	H = 250 A/m; f = 10 kHz; T = 100 °C	f = 500 kHz; $\hat{B}$ = 100 mT; T = 100 °C	f = 1 MHz; $\hat{B}$ = 30 mT; T = 100 °C	f = 1 MHz; $\hat{B}$ = 50 mT; T = 100 °C	f = 3 MHz; $\hat{B}$ = 10 mT; T = 100 °C
E+E14-3F35	≥300	≤ 0.35	–	–	–
E+PLT14-3F35	≥300	≤ 0.27	–	–	–
E+E14-3F4	≥250	–	≤ 0.09	–	≤ 0.15
E+PLT14-3F4	≥250	–	≤ 0.07	–	≤ 0.11
E+E14-3F45	≥250	–	≤ 0.06	≤ 0.15	≤ 0.11
E+PLT14-3F45	≥250	–	≤ 0.05	≤ 0.12	≤ 0.085

**MOUNTING INFORMATION**

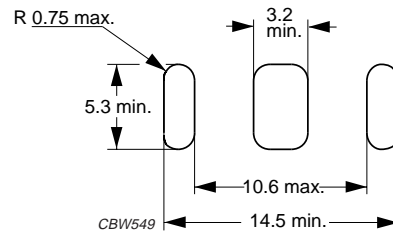
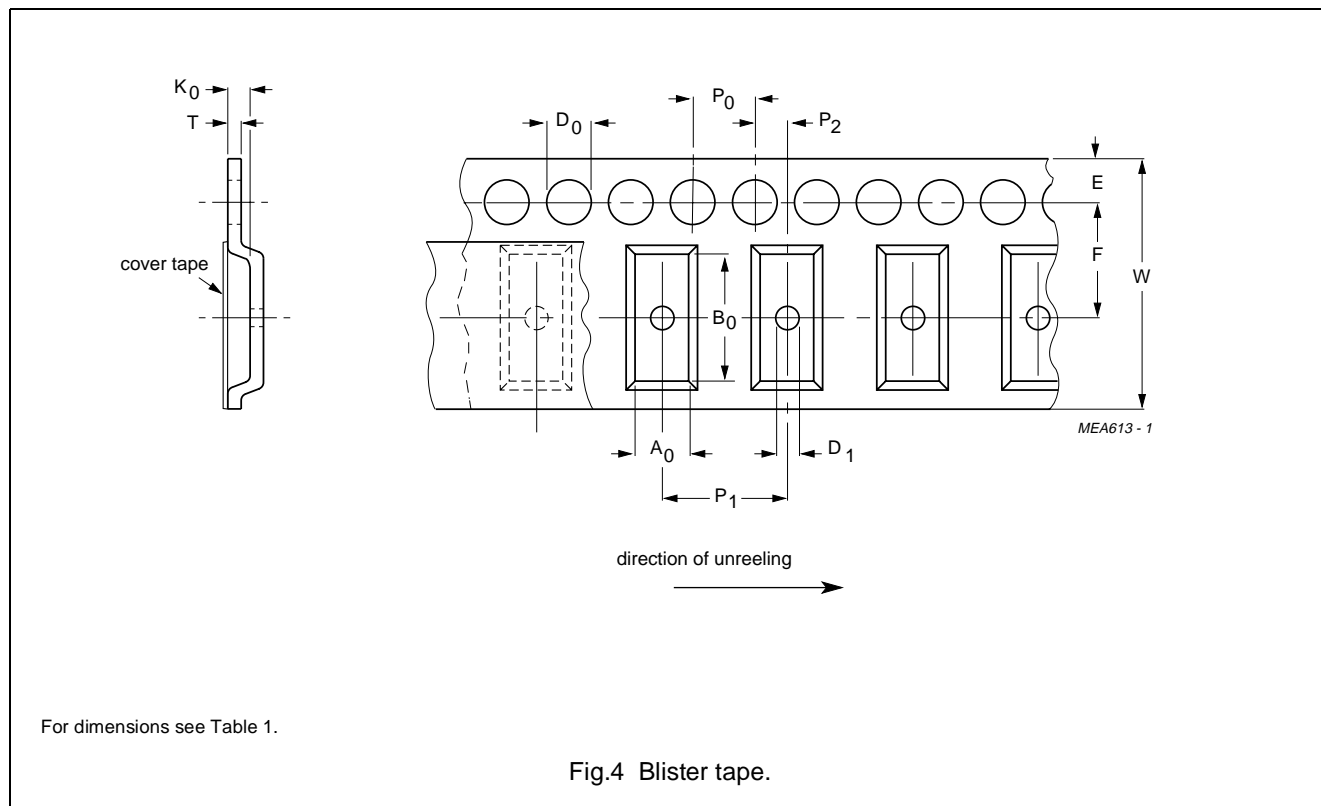

Fig.3 Recommended PCB cut-out for glued planar E14/3.5/5 cores.

**BLISTER TAPE AND REEL DIMENSIONS** prot



**Table 1** Physical dimensions of blister tape; see Fig.4

SIZE	DIMENSIONS (mm)
$A_0$	$5.4 \pm 0.2$
$B_0$	$14.6 \pm 0.2$
$K_0$	$4.0 \pm 0.2$
$T$	$0.3 \pm 0.05$
$W$	$24.0 \pm 0.3$
$E$	$1.75 \pm 0.1$
$F$	$11.5 \pm 0.1$
$D_0$	$1.5 \pm 0.1$
$D_1$	$\geq 1.5$
$P_0$	$4.0 \pm 0.1$
$P_1$	$8.0 \pm 0.1$
$P_2$	$2.0 \pm 0.1$

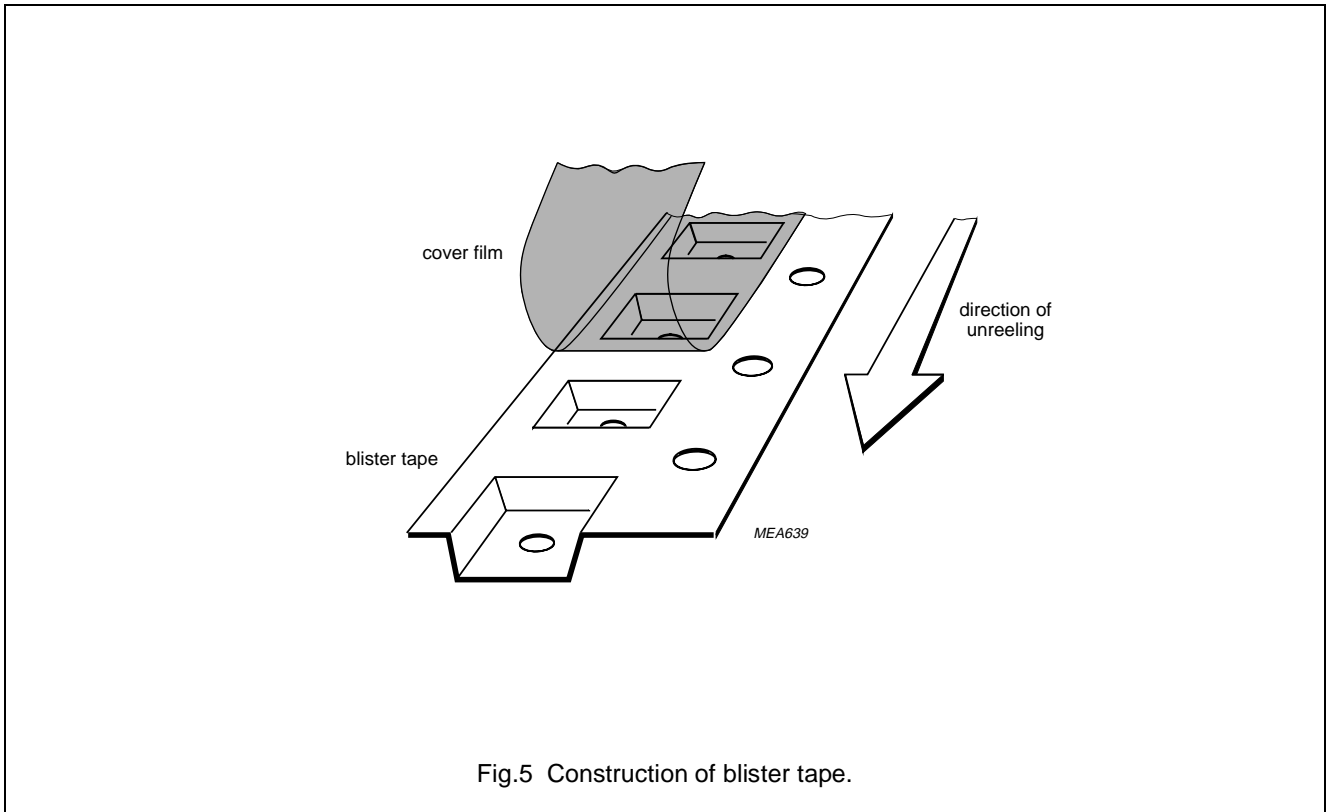
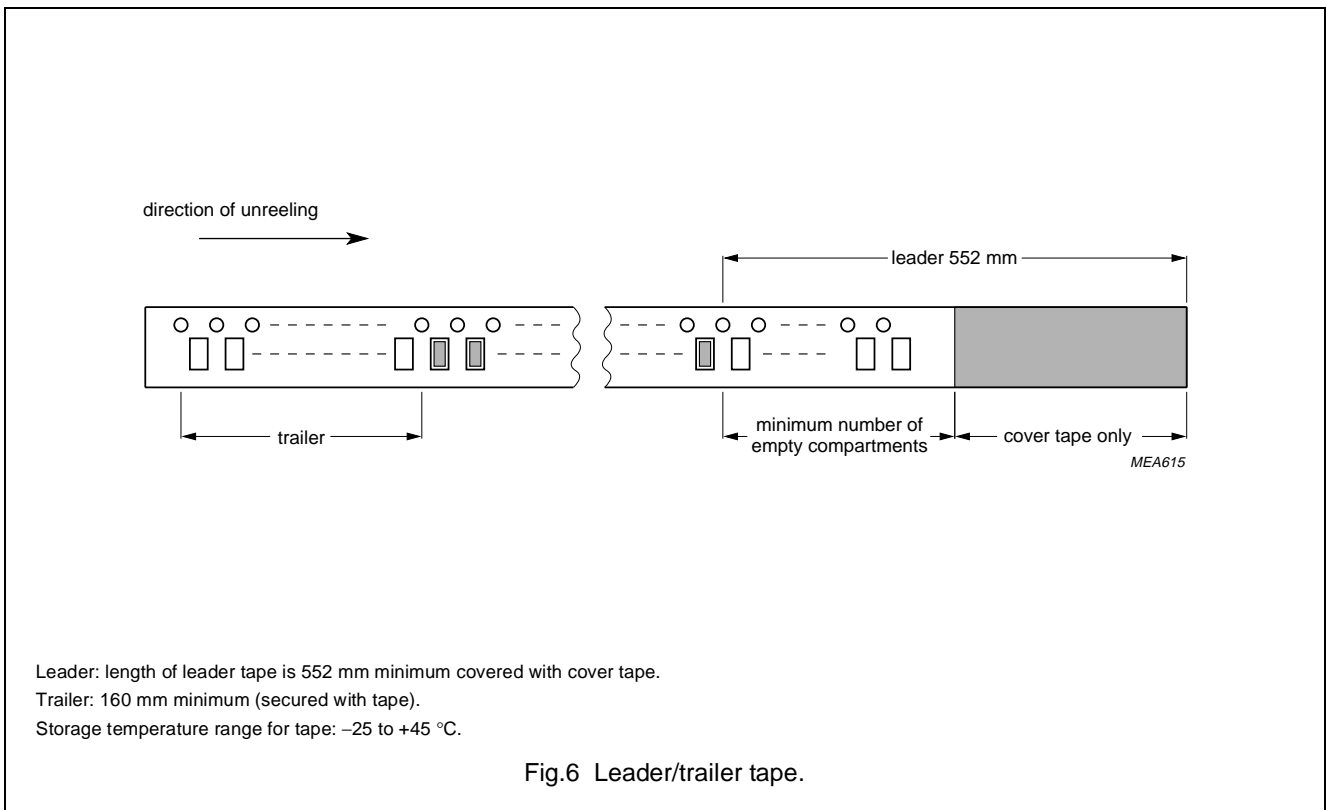

Fig.5 Construction of blister tape.



Leader: length of leader tape is 552 mm minimum covered with cover tape.  
 Trailer: 160 mm minimum (secured with tape).  
 Storage temperature range for tape: -25 to +45 °C.

Fig.6 Leader/trailer tape.



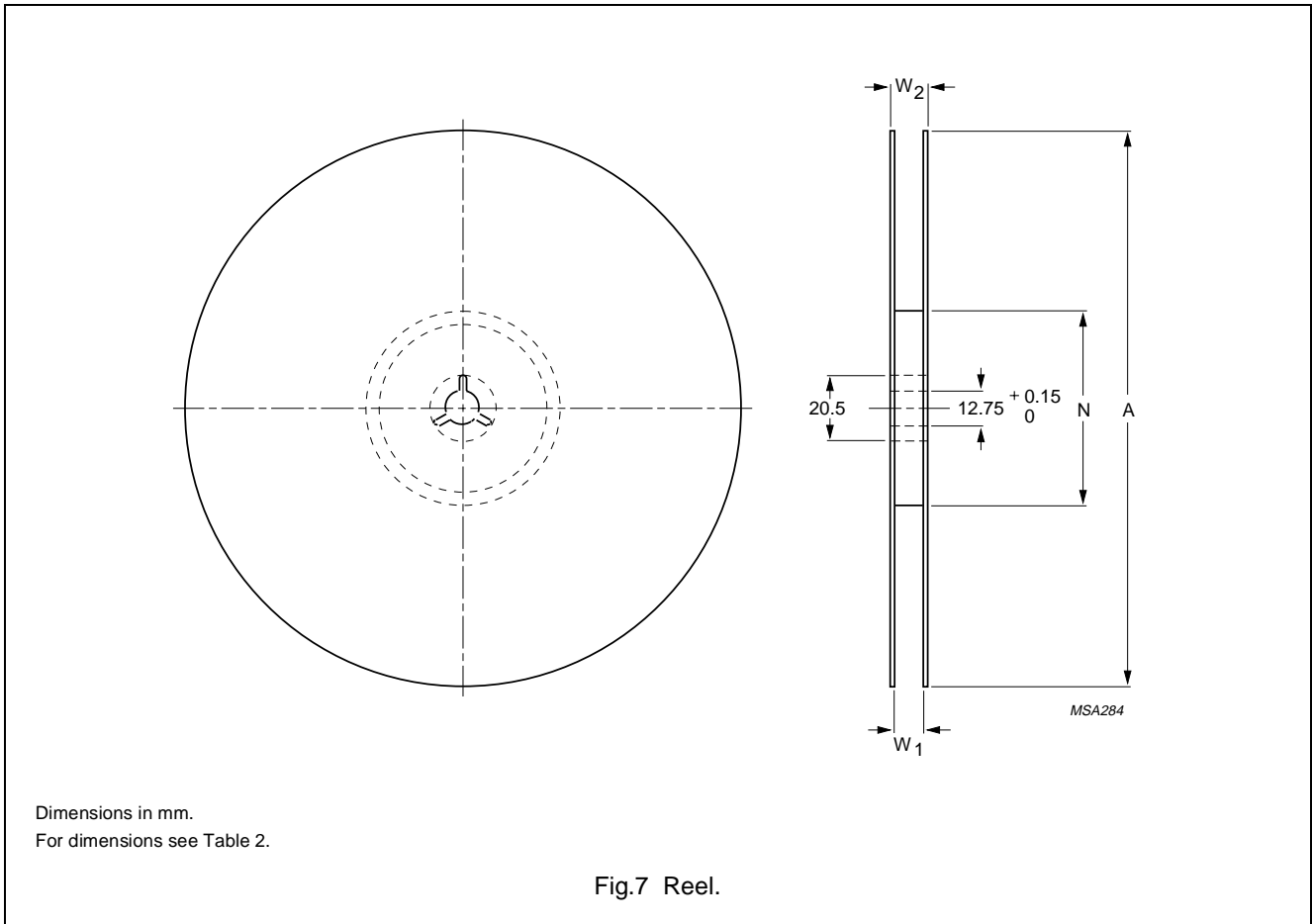

**Table 2** Reel dimensions; see Fig.7

SIZE	DIMENSIONS (mm)			
	A	N	W <sub>1</sub>	W <sub>2</sub>
24	330	100 ±5	24.4	≤28.4

## Planar E cores and accessories

E14/3.5/5



## DATA SHEET STATUS DEFINITIONS

DATA SHEET STATUS	PRODUCT STATUS	DEFINITIONS
Preliminary specification	Development	This data sheet contains preliminary data. Ferroxcube reserves the right to make changes at any time without notice in order to improve design and supply the best possible product.
Product specification	Production	This data sheet contains final specifications. Ferroxcube reserves the right to make changes at any time without notice in order to improve design and supply the best possible product.

## DISCLAIMER

**Life support applications** — These products are not designed for use in life support appliances, devices, or systems where malfunction of these products can reasonably be expected to result in personal injury. Ferroxcube customers using or selling these products for use in such applications do so at their own risk and agree to fully indemnify Ferroxcube for any damages resulting from such application.

## PRODUCT STATUS DEFINITIONS

STATUS	INDICATION	DEFINITION
<b>Prototype</b>		These are products that have been made as development samples for the purposes of technical evaluation only. The data for these types is provisional and is subject to change.
<b>Design-in</b>		These products are recommended for new designs.
<b>Preferred</b>		These products are recommended for use in current designs and are available via our sales channels.
<b>Support</b>		These products are <b>not</b> recommended for new designs and may not be available through all of our sales channels. Customers are advised to check for availability.