

DT4S-40 CURRENT COMPENSATED CHOKES

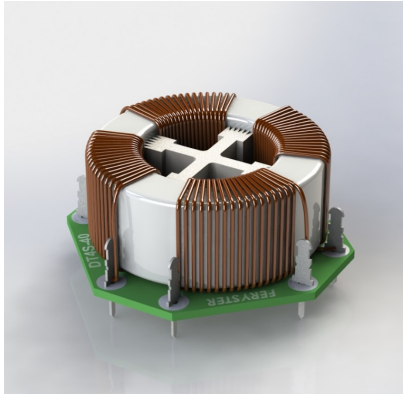

APPLICATIONS:

- LED Lighting
- Offline switching power
- Filtering on device with unstable ground
- Power line input and output filters
- Power electronics

ORDERING CODE:

DT4S-40 / 1,5 / 1,9-BH

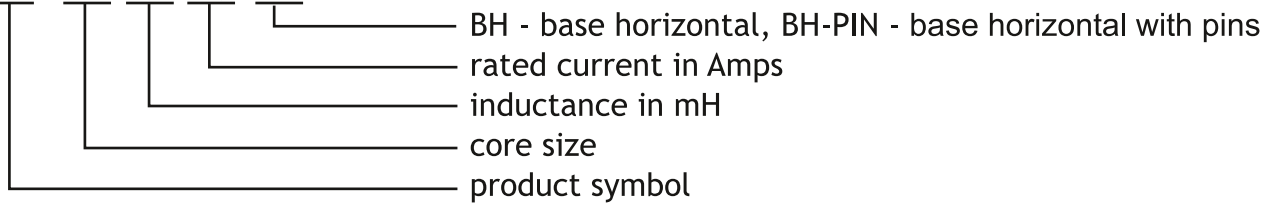

DIMENSIONS:

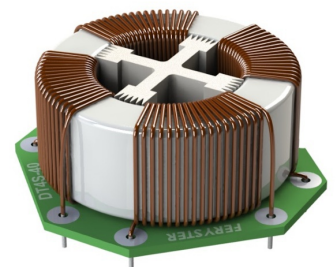
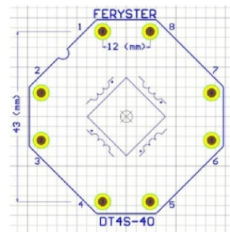
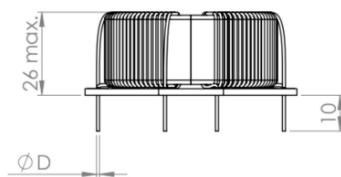
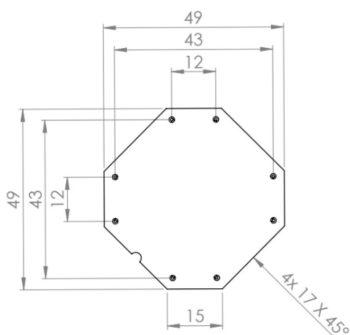

base horizontal version

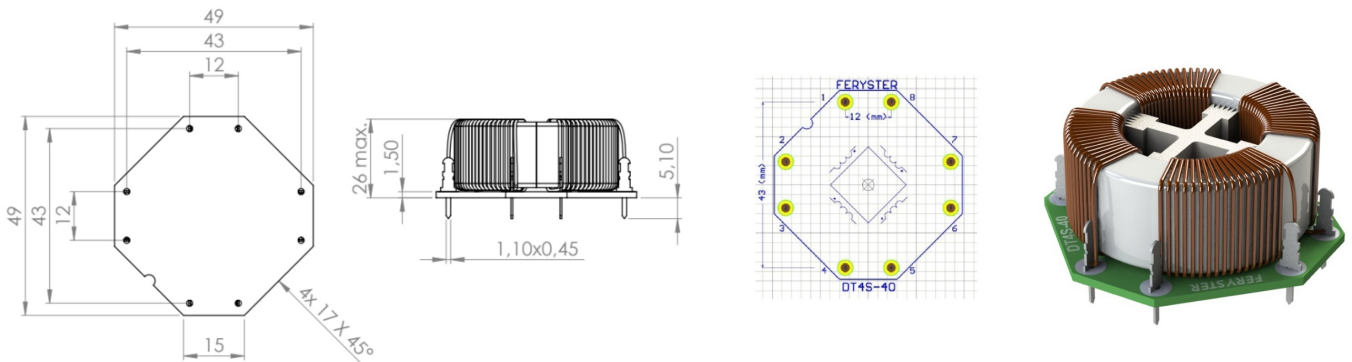

base horizontal with pins version

FOOTPRINT:

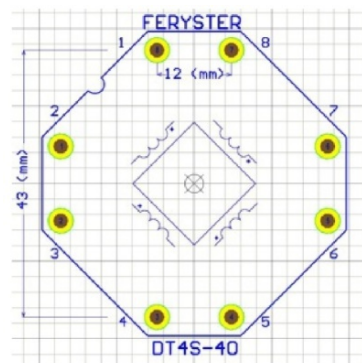

PROPERTIES:

Part number	L_{nom} [μ H] 4x	L_{min} - L_{max} [μ H] 4x	L_{max} [A]	RDC [$m\Omega$] 4x	Mounting version	
					BH	BH-PIN
DT4S-40/0,033/49	33	45-70	49	0,55	✓	-
DT4S-40/0,1/39	100	100-155	39	1,1	✓	-
DT4S-40/0,22/18	220	180-285	18	3,6	✓	-
DT4S-40/0,33/15	330	290-510	15	3,8	✓	-
DT4S-40/0,47/10	470	410-735	10	6,5	✓	-
DT4S-40/0,68/7,0	680	560-910	7	11,3	✓	-
DT4S-40/1,0/5,0	1000	930-1655	5	19,1	✓	-
DT4S-40/1,5/3,1	1500	1385-2460	3,1	39,2	✓	✓
DT4S-40/2,2/2,8	2200	1940-3485	2,8	43,5	✓	✓

- LCR meter $f=10\text{kHz}$
- RDC Cu wire resistance: $\pm 20\%$

CHARACTERISTICS:

