

DSRI-12X8 INDUCTORS



APPLICATIONS:

- modern power solutions
- AI devices
- DC/DC converters, etc.
- various categories of consumer electronics

ORDERING CODE:

DSRI-12X8 / 10 / 8

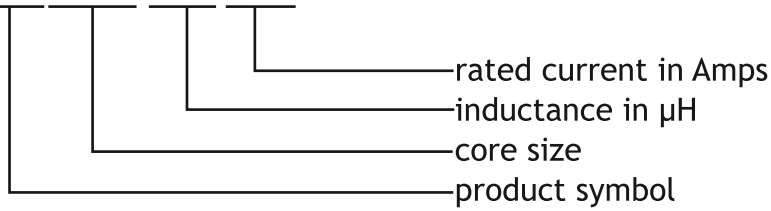

DIMENSIONS (mm):

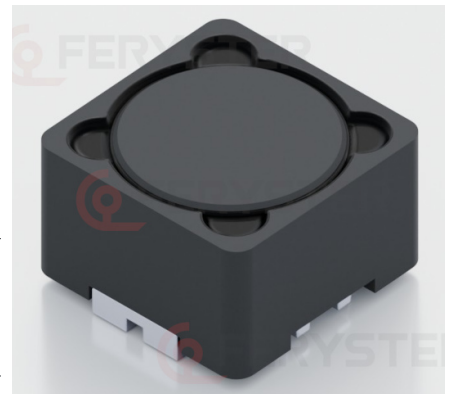
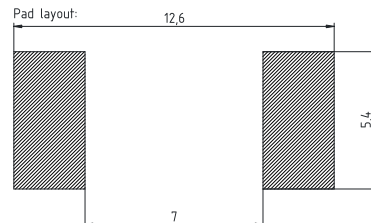
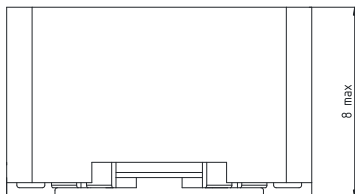
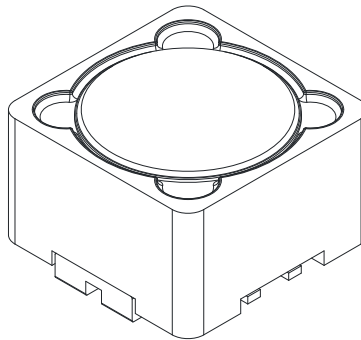
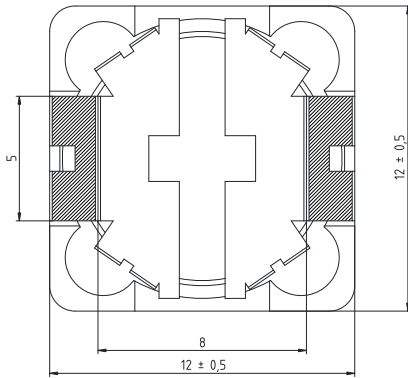

FOOTPRINTS:

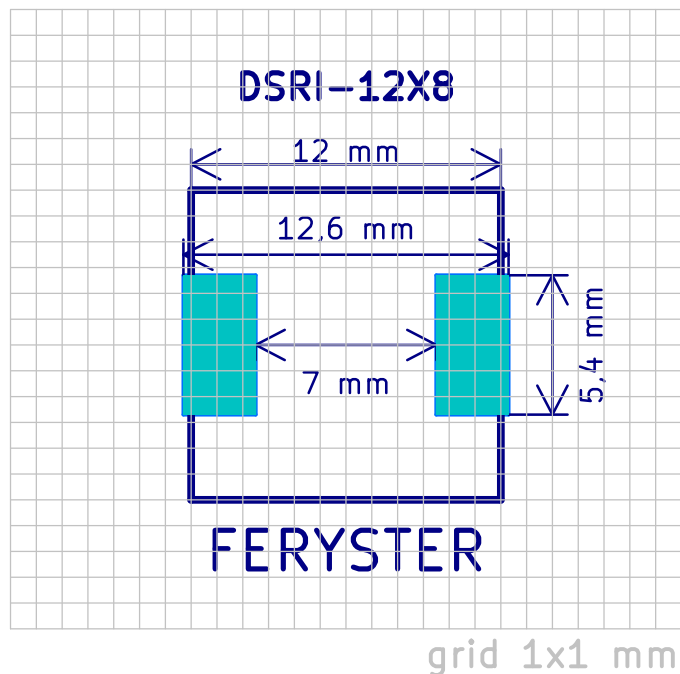

PROPERTIES:

Part number	L_{nom} [μ H]	I_{nom} [A]	RDC [m Ω]	$\Delta T@I_{nom}$ [$^{\circ}$ C]*
DSRI-12X8/10/8	10	8	24	64
DSRI-12X8/15/7	15	7	27	65
DSRI-12X8/22/5,5	22	5,5	43	50
DSRI-12X8/33/3,5	33	3,5	65	40
DSRI-12X8/47/3,3	47	3,3	100	42
DSRI-12X8/68/3,1	68	3,1	130	55
DSRI-12X8/100/2,9	100	2,9	220	59

* winding losses only.

- Inductance tolerance: $\pm 20\%$
- LCR meter $f=10\text{kHz}/0,3\text{V}$
- RDC Cu wire resistance: $\pm 20\%$