

6 5 4 3 2 1

D

D

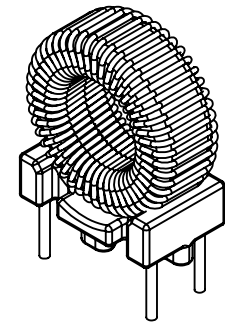

C

C

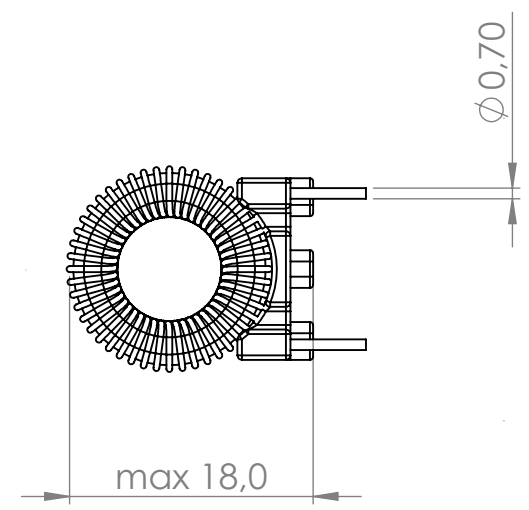
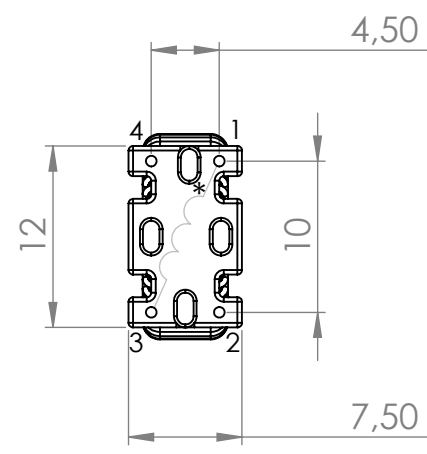

B

B

A

A

FERYSTER

NR RYSUNKU

DTMSS-12-BV

A4

SKALA:2:1

ARKUSZ 1 Z 1

\*Wymiary elementów podano w karcie katalogowej wyrobu.

6 5 4 3 2 1